

PROYECTO:

**Módulo multifuncional
10 Pies
Cortina Frontal**

ARQUITECTO:

Javier Mera

DISEÑO:

Ana Miranda

APROBADO:

Didier Van Den Hove

OBSERVACIONES:

FECHA:

23 Junio 2014

PLANO N:

1/4

ESCALA:

1:50 mts

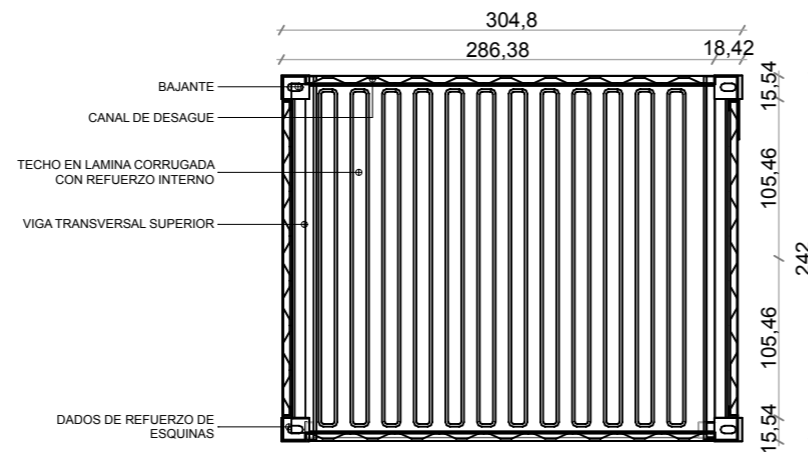

PLANTA

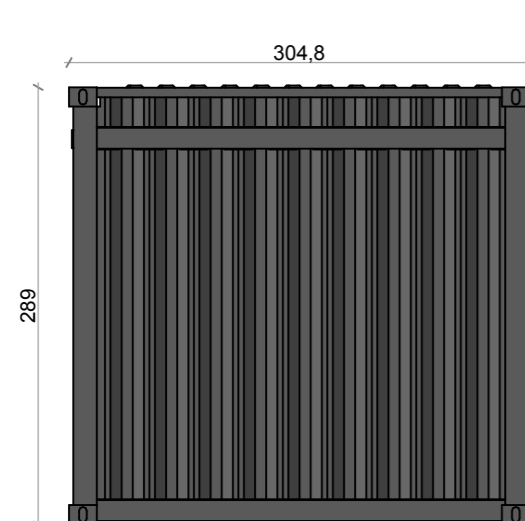

POSTERIOR

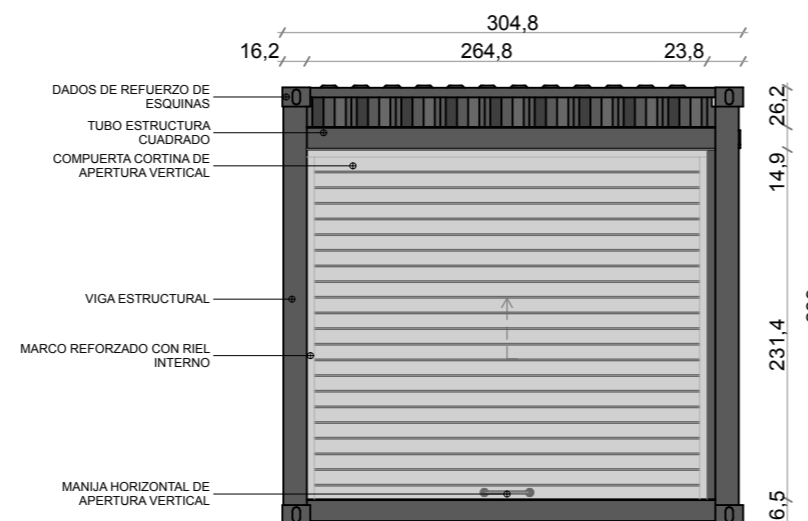

ALZADO

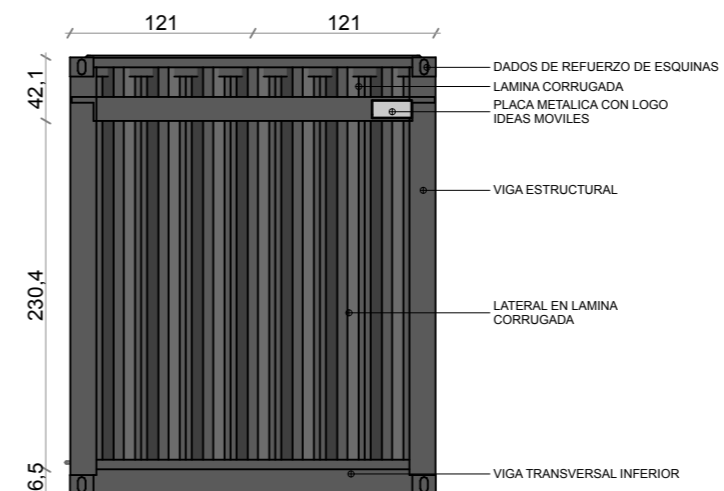

LATERAL DERECHO